

Data Sheet



Article number: 0108055

Description: Retaining ring JK 38 DIN 984

Measures

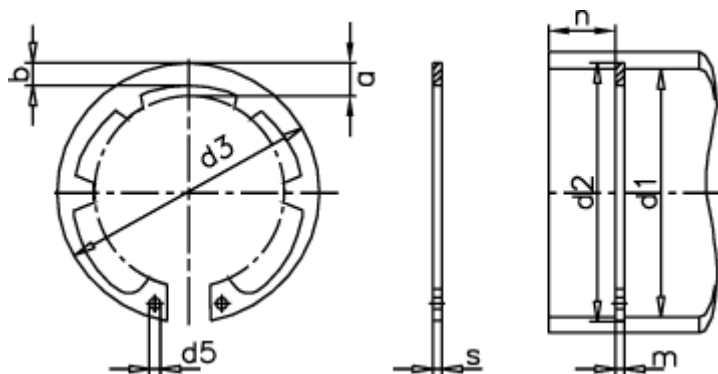

a max	= 6.1	FN kN	= 22.5	s	= 1.50
AN mm ²	= 123.0	FRg kN	= 6.7	t	= 1.00
b	= 38.0	FR kN	= 28.2	tol	= +0,25
d1	= 38	g	= 1.5	tol	= -0.06
d2	= 40.0	K kN-mm	= 51.7	tol	= +0,50-0,25
d3	= 40.8	m min	= 1.60	Tong	= ZGJ-2
d5 min	= 2.5	Nominal drive	= 3.0	Weight kg/1000	= 4.40
Description	= JK 38	Number of serrations	= 6		